

Revisions

Issue	Date	Note
1	26/03/2024	See GTXPDC/921

DATASHEET

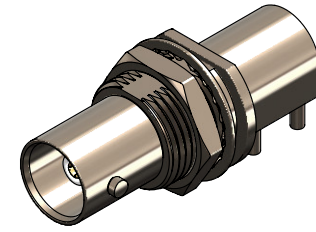

1. Mechanical

Fixing Method PCB
 Durability 500 mating cycles

2. Environmental

RoHS Compliant Yes
 Temperature Range -40 to +85 degrees C

3. Electrical

Dielectric Withstanding 1500 Volts RMS Maximum
 Impedance 75 ohms
 Interface Frequency 1 GHz
 Working Voltage 500 Volts RMS Maximum

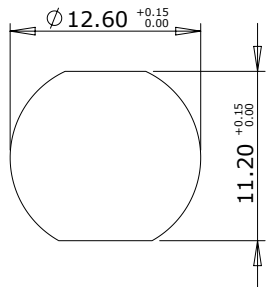

Panel Cut Out

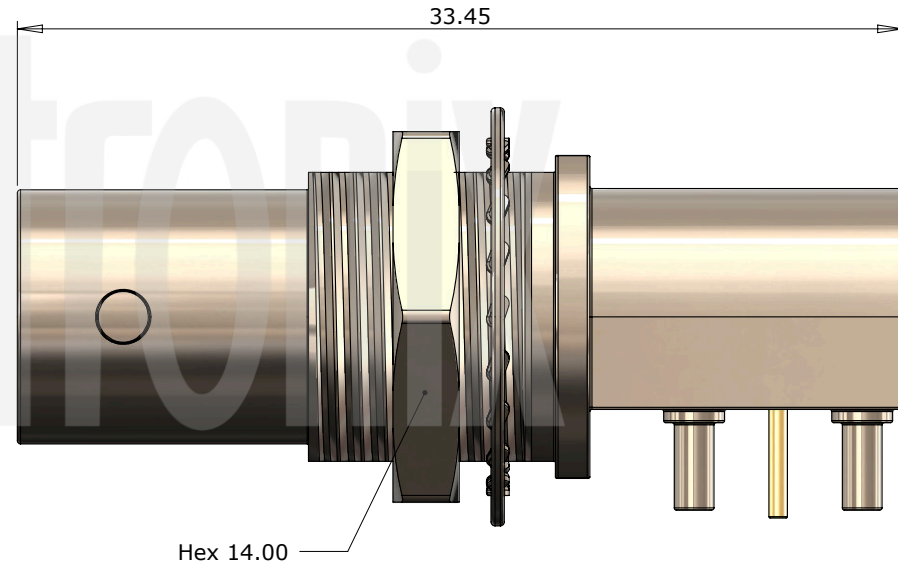

Hex 14.00

5	Washer	Steel	Nickel
4	Lock Nut	Brass	Nickel
3	Dielectric	TPX	White
2	Contact	Phosphor Bronze	Gold
1	Body	Zinc Alloy	Nickel
	Description	Material	Finish

Unless otherwise specified tolerances
 0.5-5 = ±0.2
 >5-30 = ±0.4
 >30-120 = ±0.6
 >120-315 = ±1.0
 >315-1000 = ±1.6
 Angles = ±5°
 Units = mm

This document is the confidential property of Gigatronix Limited and may not be copied, reproduced or transmitted to any third party without written authorisation.



Author	PJP
Drawn by	PJP
Drawing date	26/03/2024
Checked by	DB
Checked date	26/03/2024
Scale	Not to scale

Part Number BN02-X600-N11-5
Title: BNC Shielded Right Angle PCB Mount Jack, Nickel Plated, 75 ohms, Extra Low Profile